

RC Standard marker cards

Each marker card contains 10 strips of 10 markers, i.e. 100 markers per card.

Marker cards are white polyamide 6 with black lettering.

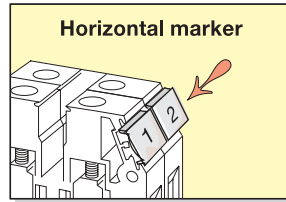

Horizontal marker See page 1930 for most popular.

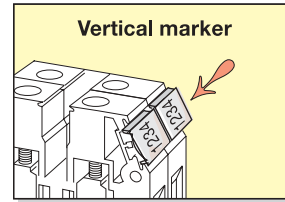

Vertical marker See page 1933 for most popular.

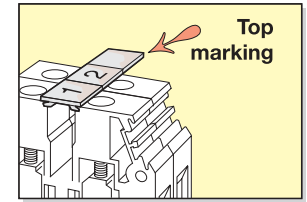

Top marking See page 1937.

How to use

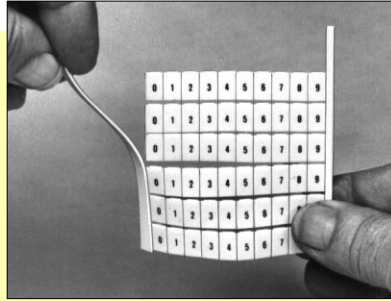

1

Remove one of the side bands of the card.

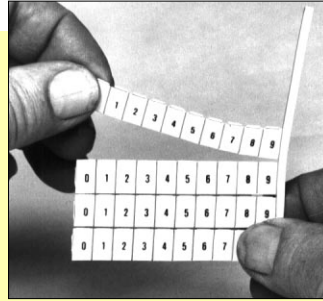

2

Separate the chosen strip from the rest of the card.

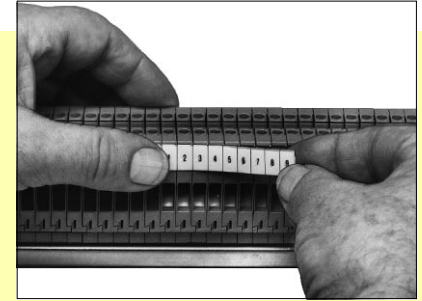

3

- Strips of 10 markers for block spacings 5 mm .197", 6 mm .236" and 8 mm .315": Press the first marker in place, hold it and slide your thumb on the rest of the strip to snap each marker on the terminal block assembly.
- Single markers : Press the chosen marker in place, hold it and tear off the rest of the strip.

Marker sizes

RC55
5 x 5 mm markers
.197" x .197".
Can be used on blocks from 5 mm .197" spacing, with possibility of mounting 2 markers per slot.

RC65
6 x 5 mm markers
.236" x .197".
Can be used on blocks from 6 mm .236" spacing, with possibility of mounting 2 markers per slot.

RCAL85
8 x 5 mm markers
.315" x .197".
Can be used on 8 mm .315" spacing spring connection blocks & mini ADO blocks.

RC410
4 x 10 mm markers
.157" x .394".
Can be used on blocks from 4 mm .157" spacing, 1 marker per slot.

RC510
5 x 10 mm markers
.197" x .394".
Can be used on blocks from 5 mm .197" spacing, 1 marker per slot.

RC610
6 x 10 mm markers
.236" x .394".
Can be used on blocks from 6 mm .236" spacing, 1 marker per slot.

RC810
8 x 10 mm markers
.315" x .394".
Can be used on blocks from 8 mm .315" spacing, 1 marker per slot.

RC1010
10 x 10 mm markers
.394" x .394".
Can be used on blocks from 10 mm .394" spacing, 1 marker per slot.

The marker that goes into the terminal block slot for each marking method is listed here :

Marker	Marking method
RC410	③
RC55	⑤ ⑩
RC510	⑥ ⑩
RC65	⑤ ⑪
RC610	⑥ ⑪
RCAL85	⑫
RC810	⑰
RC1010	⑲

Standard marker cards	Marker width mm	Marker height, L mm	Use with terminal block thickness
RC410	4	10	4 mm
RC55	5	5	5 mm
RC510	5	10	5 mm
RC65	6	5	6 mm
RC610	6	10	6 mm
RCAL85	8	5	8 mm
RC810	8	10	8 mm and larger
RC1010	10	10	10 mm and larger

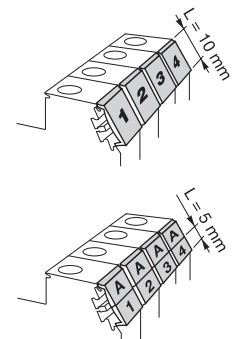

Blank marker cards	RC410	RC55	RC510	RC65
	white 0229 000.15	white 0230 000.12	white 0231 000.07	red 0103 776.01 blue 0103 775.00 white 0232 000.00
	RC610	RCAL85	RC810	
	white 0233 000.01 green 0206 230.11 yellow 0206 231.06 orange 0206 232.07	blue 0206 233.00 purple 0206 234.01 red 0206 235.02	white 0237 000.05	white 0234 000.02
	RC1010			white 0238 000.16
Mürplastik markers for terminal blocks	RC510A white 0231 500.01	RC610A white 0233 500.03	RC810A white 0234 500.04	

Card holder for item above 0205 462.05

RC Standard marker cards (cont.)

Horizontal marking of numbers

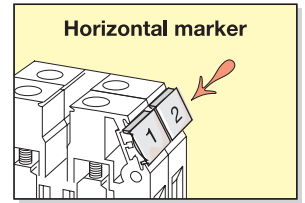
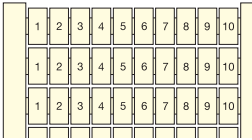

Horizontal marking
Repeated increasing order 10 times

RC55		RC510		RC65		RC610		RC810	
0 → 9	0230 001.07	0 → 9	0231 001.24	0 → 9	0232 001.25	0 → 9	0233 001.26	0 → 9	0234 001.27
1 → 10	0230 002.00	1 → 10	0231 002.25	1 → 10	0232 002.26	1 → 10	0233 002.27	1 → 10	0234 002.20
11 → 20	0230 003.01	11 → 20	0231 003.26	11 → 20	0232 003.27	11 → 20	0233 003.20	11 → 20	0234 003.21
21 → 30	0230 004.02	21 → 30	0231 004.27	21 → 30	0232 004.20	21 → 30	0233 004.21	21 → 30	0234 004.22
31 → 40	0230 005.03	31 → 40	0231 005.20	31 → 40	0232 005.21	31 → 40	0233 004.21	31 → 40	0234 005.23
41 → 50	0230 006.04	41 → 50	0231 006.21	41 → 50	0232 006.22	31 → 40	0233 005.22	41 → 50	0234 006.24
51 → 60	0230 007.05	51 → 60	0231 007.22	51 → 60	0232 007.23	41 → 50	0233 006.23	51 → 60	0234 007.25
61 → 70	0230 008.16	61 → 70	0231 008.03	61 → 70	0232 008.04	51 → 60	0233 007.24	61 → 70	0234 008.06
71 → 80	0230 009.17	71 → 80	0231 009.04	71 → 80	0232 009.05	61 → 70	0233 008.05	71 → 80	0234 009.07
81 → 90	0230 010.03	81 → 90	0231 010.20	81 → 90	0232 010.21	71 → 80	0233 009.06	81 → 90	0234 010.23
91 → 100	0230 011.20	91 → 100	0231 011.15	91 → 100	0232 011.16	81 → 90	0233 010.22	91 → 100	0234 011.10
101 → 110	0230 012.21	101 → 110	0231 012.16	101 → 110	0232 012.17	91 → 100	0233 011.17	101 → 110	0234 012.11
111 → 120	0230 013.22	111 → 120	0231 013.17	111 → 120	0232 013.10	101 → 110	0233 012.10	111 → 120	0234 013.12
121 → 130	0230 014.23	121 → 130	0231 014.10	121 → 130	0232 014.11	111 → 120	0233 013.11	121 → 130	0234 014.13
131 → 140	0230 015.24	131 → 140	0231 015.11	131 → 140	0232 015.12	121 → 130	0233 014.12	131 → 140	0234 015.14
141 → 150	0230 016.25	141 → 150	0231 016.12	141 → 150	0232 016.13	131 → 140	0233 015.13	141 → 150	0234 016.15
151 → 160	0230 017.26	151 → 160	0231 017.13	151 → 160	0232 017.14	141 → 150	0233 016.14	151 → 160	0234 017.16
161 → 170	0230 018.07	161 → 170	0231 018.24	161 → 170	0232 018.25	151 → 160	0233 017.15	161 → 170	0234 018.27
171 → 180	0230 019.00	171 → 180	0231 019.25	171 → 180	0232 019.26	161 → 170	0233 018.26	171 → 180	0234 019.20
181 → 190	0230 020.05	181 → 190	0231 020.22	181 → 190	0232 020.23	171 → 180	0233 019.27	181 → 190	0234 020.25
191 → 200	0230 021.22	191 → 200	0231 021.17	191 → 200	0232 021.10	181 → 190	0233 020.24	191 → 200	0234 021.12
201 → ...	0230 022.23*	201 → ...	0231 022.10*	201 → ...	0232 022.11*	191 → 200	0233 021.11	201 → ...	0234 022.13*
... → 999		... → 999		... → 999		... → 999	201 → 210	0233 022.12	
						211 → 220	0233 023.13		
						221 → 230	0233 024.14		
						231 → 240	0233 025.15		
						241 → 250	0233 026.16		
						251 → 260	0233 027.17		
						261 → 270	0233 028.20		
						271 → 280	0233 029.21		
						281 → 290	0233 030.23		
						291 → 300	0233 031.10		
						301 → 310	0233 032.11		
						311 → 320	0233 033.12		
						321 → 330	0233 034.13		
						331 → 340	0233 035.14		
						341 → 350	0233 036.15		
						351 → 360	0233 037.16		
						361 → 370	0233 038.27		
						371 → 380	0233 039.20		
						381 → 390	0233 040.02		
						391 → 400	0233 041.27		
						401 → 410	0233 042.20		
						411 → 420	0233 043.21		
						421 → 430	0233 044.22		
						431 → 440	0233 045.23		
						441 → 450	0233 046.24		
						451 → 460	0233 047.25		
						461 → 470	0233 048.06		
						471 → 480	0233 049.07		
						481 → 490	0233 050.23		
						491 → 500	0233 051.25		
						501 → ...	0233 121.12*		
						... → 999			

Markers	Marking method	Marker width mm	Marker height, L mm	Use with terminal block thickness
RC55	⑤ ⑩	5	5	5 mm
RC510	⑥ ⑩	5	10	5 mm
RC65	⑤ ⑪	6	5	6 mm
RC610	⑥ ⑪	6	10	6 mm
RC810	⑥ ⑰	8	10	8 mm and larger

* Part numbers identical for each group of numbers : on request (indicate marking)
Ex. : 0230 022.23 : 301 to 310.

RC Standard marker cards (cont.)

Horizontal marking of numbers (cont.)

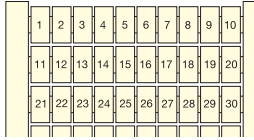

MOST POPULAR

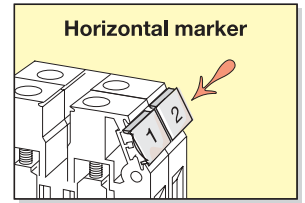

Horizontal marker
For vertical markers, see page 1933.

Horizontal marking
Increasing order

RCAL85

1 → 100 **0237 030.22**
See page 1936.

RC55		RC510		RC65		RC610		RC810	
1 → 100	0230 030.07	1 → 100	0231 030.24	1 → 100	0232 030.25	1 → 100	0233 030.26	1 → 100	0234 030.27
101 → 200	0230 031.24	101 → 200	0231 031.11	101 → 200	0232 031.12	101 → 200	0233 031.13	101 → 200	0234 031.14
201 → 300	0230 032.25	201 → 300	0231 032.12	201 → 300	0232 032.13	201 → 300	0233 032.14	201 → 300	0234 032.15
301 → 400	0230 033.26	301 → 400	0231 033.13	301 → 400	0232 033.14	301 → 400	0233 033.15	301 → 400	0234 033.16
401 → 500	0230 034.34	401 → 500	0231 034.14	401 → 500	0232 034.15	401 → 500	0233 034.16	401 → 500	0234 034.17
501 → 600	0230 035.20	501 → 600	0231 035.15	501 → 600	0232 035.16	501 → 600	0233 035.17	501 → 600	0234 035.10
601 → 700	0230 036.21	601 → 700	0231 036.16	601 → 700	0232 036.17	601 → 700	0233 036.10	601 → 700	0234 036.11
701 → 800	0230 037.22	701 → 800	0231 037.17	701 → 800	0232 037.10	701 → 800	0233 074.26	701 → 800	0234 037.12
801 → 900	0230 038.03	801 → 900	0231 038.20	801 → 900	0232 038.21	801 → 900	0233 075.27	801 → 900	0234 038.23
901 → 1000	0230 039.04	901 → 1000	0231 039.21	901 → 1000	0232 039.22	901 → 1000	0233 076.20	901 → 1000	0234 039.24
1001 →	0230 071.04*	1001 →	0231 071.21*	1001 →	0232 071.22*	1001 →	0233 073.25*	1001 →	0234 071.24*

* Part numbers identical for each group of numbers : on request (indicate marking). Ex. : 0230 071.04 : 1001 to 1100.

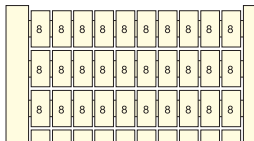

Horizontal marking
Repeated identical numbers

Markers	Marking method	Marker width mm	Marker height, L mm	Use with terminal block thickness
RC55	⑤ ⑩	5	5	5 mm
RC510	⑥ ⑩	5	10	5 mm
RC65	⑤ ⑪	6	5	6 mm
RC610	⑥ ⑪	6	10	6 mm
RC810	⑥ ⑰	8	10	8 mm and larger

RC55		RC510		RC65		RC610	
100 x 0	0230 240.26	100 x 0	0231 210.05	100 x 0	0232 201.02	100 x 0	0233 201.03
100 x 1	0230 241.13	100 x 1	0231 211.22	100 x 1	0232 202.03	100 x 1	0233 202.04
100 x 2	0230 242.14	100 x 2	0231 212.23	100 x 2	0232 203.04	100 x 2	0233 203.05
100 x 3	0230 243.15	100 x 3	0231 213.24	100 x 3	0232 204.05	100 x 3	0233 204.06
100 x 4	0230 244.16	100 x 4	0231 214.25	100 x 4	0232 205.06	100 x 4	0233 205.07
100 x 5	0230 245.17	100 x 5	0231 215.26	100 x 5	0232 206.07	100 x 5	0233 206.00
100 x 6 or 9	0230 246.10	100 x 6 or 9	0231 216.27	100 x 6 or 9	0232 207.00	100 x 6 or 9	0233 207.01
100 x 7	0230 247.11	100 x 7	0231 217.20	100 x 7	0232 208.11	100 x 7	0233 208.12
100 x 8	0230 248.22	100 x 8	0231 218.01	100 x 8	0232 209.12	100 x 8	0233 209.13
100 x 10	0230 250.20	100 x 10	0231 220.07	100 x 10	0232 211.23	100 x 10	0233 211.24
100 x 11	0230 251.15	100 x 11	0231 221.24	100 x 11	0232 212.24	100 x 11	0233 212.25
100 x 12	0230 252.16	100 x 12	0231 222.25	100 x 12	0232 213.25	100 x 12	0233 213.26
100 x 13	0230 253.17	100 x 13	0231 223.26	100 x 13	0232 214.26	100 x 13	0233 214.27
100 x 14	0230 254.10	100 x 14	0231 224.27	100 x 14	0232 215.27	100 x 14	0233 215.20
100 x 15	0230 255.11	100 x 15	0231 225.20	100 x 15	0232 216.20	100 x 15	0233 216.21
100 x 16	0230 256.12	100 x 16	0231 226.21	100 x 16	0232 217.21	100 x 16	0233 217.22
100 x 17	0230 257.13	100 x 17	0231 227.22	100 x 17	0232 218.02	100 x 17	0233 218.03
100 x 18	0230 258.24	100 x 18	0231 228.03	100 x 18	0232 219.03	100 x 18	0233 219.04
100 x 19	0230 259.25	100 x 19	0231 229.04	100 x 19	0232 220.00	100 x 19	0233 220.01
100 x 20	0230 260.22	100 x 20	0231 230.01	100 x 20	0232 221.25	100 x 20	0233 221.26
		100 x ... } 999	0231 231.26*	100 x ... } 999	0232 222.26*	100 x ... } 999	0233 222.27*

* Part numbers identical for each group of numbers : on request (indicate marking). Ex. : 0231 231.26 : 100 x 21.

RC Standard marker cards (cont.)

Horizontal marking of numbers (cont.)

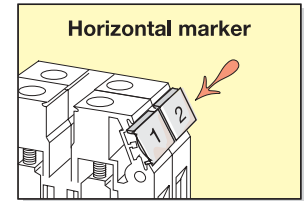

1	3	5	7	9	11	13	15	17	19
2	4	6	8	10	12	14	16	18	20
21	23	25	27	29	31	33	35	37	39

RC65

1	→	20	0232 133.15
21	→	40	0232 134.16
41	→	60	0232 135.17
61	→	80	0232 136.10
81	→	100	0232 137.11

RC610

1	→	20	0233 133.16
21	→	40	0233 134.17
41	→	60	0233 135.10
61	→	80	0233 136.11
81	→	100	0233 137.12

Horizontal marking
Alternate even/odd numbered
for 2 deck block **M 4/6.D**

1	2	3	4	5	6	7	8	9
1	2	3	4	5	6	7	8	9
1	2	3	4	5	6	7	8	9

Horizontal marking
Increasing order repeated 10 times

1	2	3	4	5	6	7	8	9	10
11	12	13	14	15	16	17	18	19	20
21	22	23	24	25	26	27	28	29	30

Horizontal marking
Increasing order 2 times

Markers	Marking method	Marker width mm	Marker height, L mm	Use with terminal block thickness
RC55	⑤ ⑩	5	5	5 mm
RC510	⑥ ⑩	5	10	5 mm
RC65	⑤ ⑪	6	5	6 mm
RC610	⑥ ⑪	6	10	6 mm
RC810	⑥ ⑰	8	10	8 mm and larger

RC610

10 x 1	→	9	0233 142.27
+ blank			

RC610

2 x 1	→	50	0233 141.26
-------	---	----	--------------------

RC810

10 x 1	→	9	0234 130.20
+ blank			

Horizontal marking of letters

A	A	A	A	A	A	A	A	A	A
A	A	A	A	A	A	A	A	A	A
A	A	A	A	A	A	A	A	A	A

Horizontal marking
Repeated identical letters

RC55

100 x A	0230 150.14
100 x B	0230 151.01
100 x C	0230 152.02
100 x D	0230 153.03
100 x E	0230 154.04
100 x F	0230 155.05
100 x G	0230 156.06
100 x H	0230 157.07
100 x I	0230 158.10
100 x J	0230 159.11
100 x K	0230 160.16
100 x L	0230 161.03
100 x M	0230 162.04
100 x N	0230 163.05
100 x O	0230 164.06
100 x P	0230 165.07
100 x Q	0230 166.00
100 x R	0230 167.01
100 x S	0230 168.12
100 x T	0230 169.13
100 x U	0230 170.10
100 x V	0230 171.05
100 x W	0230 172.06
100 x X	0230 173.07
100 x Y	0230 174.00
100 x Z	0230 175.01

RC510

100 x A	0231 150.01
100 x B	0231 151.26
100 x C	0231 152.27
100 x D	0231 153.20
100 x E	0231 154.21
100 x F	0231 155.22
100 x G	0231 156.23
100 x H	0231 157.24
100 x I	0231 158.05
100 x J	0231 159.06
100 x K	0231 160.03
100 x L	0231 161.20
100 x M	0231 162.21
100 x N	0231 163.22
100 x O	0231 164.23
100 x P	0231 165.24
100 x Q	0231 166.25
100 x R	0231 167.26
100 x S	0231 168.07
100 x T	0231 169.00
100 x U	0231 170.05
100 x V	0231 171.22
100 x W	0231 172.23
100 x X	0231 173.24
100 x Y	0231 174.25
100 x Z	0231 175.26

RC65

100 x A	0232 150.02
100 x B	0232 151.27
100 x C	0232 152.20
100 x D	0232 153.21
100 x E	0232 154.22
100 x F	0232 155.23
100 x G	0232 156.24
100 x H	0232 157.25
100 x I	0232 158.06
100 x J	0232 159.07
100 x K	0232 160.04
100 x L	0232 161.21
100 x M	0232 162.22
100 x N	0232 163.23
100 x O	0232 164.24
100 x P	0232 165.25
100 x Q	0232 166.26
100 x R	0232 167.27
100 x S	0232 168.00
100 x T	0232 169.01
100 x U	0232 170.06
100 x V	0232 171.23
100 x W	0232 172.24
100 x X	0232 173.25
100 x Y	0232 174.26
100 x Z	0232 175.27

RC610

100 x A	0233 150.03
100 x B	0233 151.20
100 x C	0233 152.21
100 x D	0233 153.22
100 x E	0233 154.23
100 x F	0233 155.24
100 x G	0233 156.25
100 x H	0233 157.26
100 x I	0233 158.07
100 x J	0233 159.00
100 x K	0233 160.05
100 x L	0233 161.22
100 x M	0233 162.23
100 x N	0233 163.24
100 x O	0233 164.25
100 x P	0233 165.26
100 x Q	0233 166.27
100 x R	0233 167.20
100 x S	0233 168.01
100 x T	0233 169.02
100 x U	0233 170.07
100 x V	0233 171.24
100 x W	0233 172.25
100 x X	0233 173.26
100 x Y	0233 174.27
100 x Z	0233 175.20

RC810

100 x A	0234 150.04
100 x B	0234 151.21
100 x C	0234 152.22
100 x D	0234 153.23
100 x E	0234 154.24
100 x F	0234 155.25
100 x G	0234 156.26
100 x H	0234 157.27
100 x I	0234 158.00
100 x J	0234 159.01
100 x K	0234 160.06
100 x L	0234 161.23
100 x M	0234 162.24
100 x N	0234 163.25
100 x O	0234 164.26
100 x P	0234 165.27
100 x Q	0234 166.20
100 x R	0234 167.21
100 x S	0234 168.02
100 x T	0234 169.03
100 x U	0234 170.00
100 x V	0234 171.25
100 x W	0234 172.26
100 x X	0234 173.27
100 x Y	0234 174.20
100 x Z	0234 175.21

RC Standard marker cards (cont.)

Horizontal marking of conventional symbols

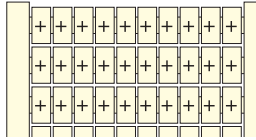
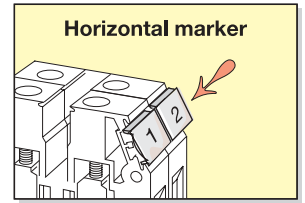

Horizontal marking
Repeated identical symbols

RC55	RC510	RC65	RC610	RC810
100 x + 0230 111.21	100 x + 0231 111.16	100 x + 0232 111.17	100 x + 0233 111.10	100 x + 0234 111.11
100 x - 0230 112.22	100 x - 0231 112.17	100 x - 0232 112.10	100 x - 0233 112.11	100 x - 0234 112.12
100 x ~ 0230 114.24	100 x ~ 0231 114.11	100 x ~ 0232 114.12	100 x ~ 0233 114.13	100 x ~ 0234 114.14
100 x = 0230 113.23	100 x = 0231 113.10	100 x = 0232 113.11	100 x = 0233 113.12	100 x = 0234 113.13
100 x ± 0230 115.25	100 x ± 0231 115.12	100 x ± 0232 115.13	100 x ± 0233 115.14	100 x ± 0234 115.15



Horizontal marking
Conventional symbols

Markers	Marking method	Marker width mm	Marker height, L mm	Use with terminal block thickness
RC55	⑤ ⑩	5	5	5 mm
RC510	⑥ ⑩	5	10	5 mm
RC65	⑤ ⑪	6	5	6 mm
RC610	⑥ ⑪	6	10	6 mm
RC810	⑥ ⑰	8	10	8 mm and larger

RC55	RC510	RC65	RC610
20 x L1-L2-L3-N-PE 0230 131.25	20 x L1-L2-L3-N-PE 0231 131.12	20 x L1-L2-L3-N-PE 0232 131.13	20 x L1-L2-L3-N-PE 0233 131.14



Horizontal marking
Conventional symbols

RC55	RC510	RC65	RC610
100 x L1 0230 116.26	100 x L1 0231 116.13	100 x L1 0232 116.14	100 x L1 0233 116.15
100 x L2 0230 117.27	100 x L2 0231 117.14	100 x L2 0232 117.15	100 x L2 0233 117.16
100 x L3 0230 118.00	100 x L3 0231 118.25	100 x L3 0232 118.26	100 x L3 0233 118.27
100 x PE 0230 119.01	100 x PE 0231 119.26	100 x PE 0232 119.27	100 x PE 0233 119.20

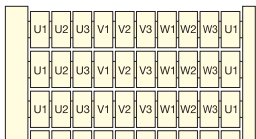

Horizontal marking
Conventional symbols

RC65	RC610
10 times U1-U2-U3-V1-V2-V3 W1-W2-W3 0232 132.14	10 times U1-U2-U3-V1-V2-V3 W1-W2-W3 0233 132.15

RC Standard marker cards (cont.)

Vertical marking of numbers

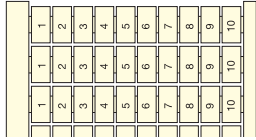

Vertical marking
Increasing order repeated 10 times

Markers	Marking method	Marker width mm	Marker height, L mm	Use with terminal block thickness
RC55	⑤ ⑩	5	5	5 mm
RC510	⑥ ⑩	5	10	5 mm
RC65	⑤ ⑪	6	5	6 mm
RC610	⑥ ⑪	6	10	6 mm
RC810	⑥ ⑰	8	10	8 mm and larger

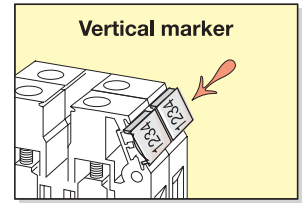

For horizontal markers, see page 1930.

RC55		RC510		RC65		RC610		RC810	
0 → 9	0230 040.11	0 → 9	0231 040.06	0 → 9	0232 040.07	0 → 9	0233 040.00	0 → 9	0234 040.01
1 → 10	0230 041.06	1 → 10	0231 041.23	1 → 10	0232 041.24	1 → 10	0233 041.25	1 → 10	0234 041.26
11 → 20	0230 042.07	11 → 20	0231 042.24	11 → 20	0232 042.25	11 → 20	0233 042.26	11 → 20	0234 042.27
21 → 30	0230 043.00	21 → 30	0231 043.25	21 → 30	0232 043.26	21 → 30	0233 043.27	21 → 30	0234 043.20
31 → 40	0230 044.01	31 → 40	0231 044.26	31 → 40	0232 044.27	31 → 40	0233 044.20	31 → 40	0234 044.21
41 → 50	0230 045.02	41 → 50	0231 045.27	41 → 50	0232 045.20	41 → 50	0233 045.21	41 → 50	0234 045.22
51 → 60	0230 046.03	51 → 60	0231 046.20	51 → 60	0232 046.21	51 → 60	0233 046.22	51 → 60	0234 046.23
61 → 70	0230 047.04	61 → 70	0231 047.21	61 → 70	0232 047.22	61 → 70	0233 047.23	61 → 70	0234 047.24
71 → 80	0230 048.15	71 → 80	0231 048.02	71 → 80	0232 048.03	71 → 80	0233 048.04	71 → 80	0234 048.05
81 → 90	0230 049.16	81 → 90	0231 049.03	81 → 90	0232 049.04	81 → 90	0233 049.05	81 → 90	0234 049.06
91 → 100	0230 050.13	91 → 100	0231 050.00	91 → 100	0232 050.01	91 → 100	0233 050.02	91 → 100	0234 050.03
101 → 110	0230 051.00	101 → 110	0231 051.25	101 → 110	0232 051.26	101 → 110	0233 051.27	101 → 110	0234 051.20
111 → 120	0230 052.01	111 → 120	0231 052.26	111 → 120	0232 052.27	111 → 120	0233 080.21	111 → 120	0234 052.21
121 → 130	0230 053.02	121 → 130	0231 053.27	121 → 130	0232 053.20	121 → 130	0233 081.16	121 → 130	0234 053.22
131 → 140	0230 054.03	131 → 140	0231 054.20	131 → 140	0232 054.21	131 → 140	0233 082.17	131 → 140	0234 054.23
141 → 150	0230 055.04	141 → 150	0231 055.21	141 → 150	0232 055.22	141 → 150	0233 083.10	141 → 150	0234 055.24
151 → 160	0230 056.05	151 → 160	0231 056.22	151 → 160	0232 056.23	151 → 160	0233 084.11	151 → 160	0234 056.25
161 → 170	0230 057.06	161 → 170	0231 057.23	161 → 170	0232 057.24	161 → 170	0233 085.12	161 → 170	0234 057.26
171 → 180	0230 058.17	171 → 180	0231 058.04	171 → 180	0232 058.05	171 → 180	0233 086.13	171 → 180	0234 058.07
181 → 190	0230 059.10	181 → 190	0231 059.05	181 → 190	0232 059.06	181 → 190	0233 087.14	181 → 190	0234 059.00
191 → 200	0230 072.05	191 → 200	0231 072.22	191 → 200	0232 072.23	191 → 200	0233 088.25	191 → 200	0234 072.25
201 → ...	0230 073.06*	201 → ...	0231 073.23*	201 → ...	0232 073.24*	201 → ...	0233 071.23*	201 → ...	0234 073.26*
... → 999		... → 999		... → 999		... → 999		... → 999	

* Part numbers identical for each group of numbers : on request (indicate marking). Ex. : 0230 073.06 : 301 to 310.

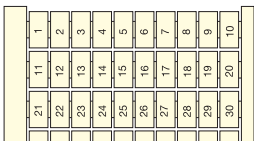

Vertical marking
Increasing marker



RC55		RC510		RC65		RC610		RC810	
1 → 100	0230 060.15	1 → 100	0231 060.02	1 → 100	0232 060.03	1 → 100	0233 060.04	1 → 100	0234 060.05
101 → 200	0230 061.02	101 → 200	0231 061.27	101 → 200	0232 061.20	101 → 200	0233 061.21	101 → 200	0234 061.22
201 → 300	0230 062.03	201 → 300	0231 062.20	201 → 300	0232 062.21	201 → 300	0233 062.22	201 → 300	0234 062.23
301 → 400	0230 063.04	301 → 400	0231 063.21	301 → 400	0232 063.22	301 → 400	0233 063.23	301 → 400	0234 063.24
401 → 500	0230 064.05	401 → 500	0231 064.22	401 → 500	0232 064.23	401 → 500	0233 064.24	401 → 500	0234 064.25
501 → 600	0230 065.06	501 → 600	0231 065.23	501 → 600	0232 065.24	501 → 600	0233 065.25	501 → 600	0234 065.26
601 → 700	0230 066.07	601 → 700	0231 066.24	601 → 700	0232 066.25	601 → 700	0233 066.26	601 → 700	0234 066.27
701 → 800	0230 067.00	701 → 800	0231 067.25	701 → 800	0232 067.26	701 → 800	0233 067.27	701 → 800	0234 067.20
801 → 900	0230 068.11	801 → 900	0231 068.06	801 → 900	0232 068.07	801 → 900	0233 068.00	801 → 900	0234 068.01
901 → 1000	0230 069.12	901 → 1000	0231 069.07	901 → 1000	0232 069.00	901 → 1000	0233 069.01	901 → 1000	0234 069.02
1001 → ...	0230 070.17*	1001 → ...	0231 070.04*	1001 → ...	0232 070.05*	1001 → ...	0233 070.06*	1001 → ...	0234 070.07*

* Part numbers identical for each group of numbers : on request (indicate marking). Ex. : 0230 070.17 : 1001 to 1100.

RC Standard marker cards (cont.)

Vertical marking of numbers (cont.)

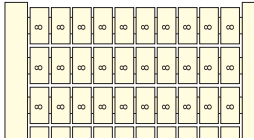

Vertical marking
Repeated identical numbers

Markers	Marking method	Marker width mm	Marker height, L mm	Use with terminal block thickness
RC55	⑤ ⑩	5	5	5 mm
RC510	⑥ ⑩	5	10	5 mm
RC65	⑤ ⑪	6	5	6 mm
RC610	⑥ ⑪	6	10	6 mm
RC810	⑥ ⑰	8	10	8 mm and larger

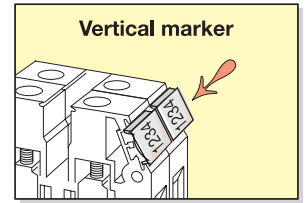

RC65

100 x 0	0232 240.14
100 x 1	0232 241.01
100 x 2	0232 242.02
100 x 3	0232 243.03
100 x 4	0232 244.04
100 x 5	0232 245.05
100 x 6 or 9	0232 246.06
100 x 7	0232 247.07
100 x 8	0232 248.10
100 x 10	0232 250.16
100 x 11	0232 251.03
100 x 12	0232 252.04
100 x 13	0232 253.05
100 x 14	0232 254.06
100 x 15	0232 255.07
100 x 16	0232 256.00
100 x 17	0232 257.01
100 x 18	0232 258.12
100 x 19	0232 259.13
100 x 20	0232 260.10
100 x ..	0232 261.05*
999	

RC610

100 x 0	0233 240.15
100 x 1	0233 241.02
100 x 2	0233 242.03
100 x 3	0233 243.04
100 x 4	0233 244.05
100 x 5	0233 245.06
100 x 6 or 9	0233 246.07
100 x 7	0233 247.00
100 x 8	0233 248.11
100 x 10	0233 250.17
100 x 11	0233 251.04
100 x 12	0233 252.05
100 x 13	0233 253.06
100 x 14	0233 254.07
100 x 15	0233 255.00
100 x 16	0233 256.01
100 x 17	0233 257.02
100 x 18	0233 258.13
100 x 19	0233 259.14
100 x 20	0233 260.11
100 x ..	0233 261.06*
999	



Vertical marking
Alternate even/odd numbered for 2 deck block **M 4/6.D**

RC610

1	→	20	0233 143.20
21	→	40	0233 144.21
41	→	60	0233 145.22
61	→	80	0233 146.23
81	→	100	0233 147.24

* Part numbers identical for each group of numbers : on request (indicate marking). Ex. : 0232 261.05 : 100 x 25.

Vertical marking of symbols

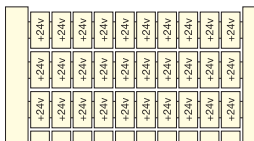

Vertical marking
Repeated identical symbols

RC610

100 x +24V	0233 124.15
100 x +48V	0233 125.16

RC Standard marker cards (cont.)

Vertical marking of letters



Vertical marking
Repeated identical letters

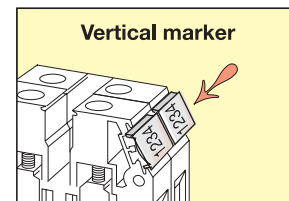

RC55		RC510		RC65		RC610		RC810	
100 x A	0230 180.03	100 x A	0231 180.20	100 x A	0232 180.21	100 x A	0233 180.22	100 x A	0234 180.23
100 x B	0230 181.20	100 x B	0231 181.15	100 x B	0232 181.16	100 x B	0233 181.17	100 x B	0234 181.10
100 x C	0230 182.21	100 x C	0231 182.16	100 x C	0232 182.17	100 x C	0233 182.10	100 x C	0234 182.11
100 x D	0230 183.22	100 x D	0231 183.17	100 x D	0232 183.10	100 x D	0233 183.11	100 x D	0234 183.12
100 x E	0230 184.23	100 x E	0231 184.10	100 x E	0232 184.11	100 x E	0233 184.12	100 x E	0234 184.13
100 x F	0230 185.24	100 x F	0231 185.11	100 x F	0232 185.12	100 x F	0233 185.13	100 x F	0234 185.14
100 x G	0230 186.25	100 x G	0231 186.12	100 x G	0232 186.13	100 x G	0233 186.14	100 x G	0234 186.15
100 x H	0230 187.26	100 x H	0231 187.13	100 x H	0232 187.14	100 x H	0233 187.15	100 x H	0234 187.16
100 x I	0230 188.07	100 x I	0231 188.24	100 x I	0232 188.25	100 x I	0233 188.26	100 x I	0234 188.27
100 x J	0230 189.00	100 x J	0231 189.25	100 x J	0232 189.26	100 x J	0233 189.27	100 x J	0234 189.20
100 x K	0230 190.05	100 x K	0231 190.22	100 x K	0232 190.23	100 x K	0233 190.24	100 x K	0234 190.25
100 x L	0230 191.22	100 x L	0231 191.17	100 x L	0232 191.10	100 x L	0233 191.11	100 x L	0234 191.12
100 x M	0230 192.23	100 x M	0231 192.10	100 x M	0232 192.11	100 x M	0233 192.12	100 x M	0234 192.13
100 x N	0230 193.24	100 x N	0231 193.11	100 x N	0232 193.12	100 x N	0233 193.13	100 x N	0234 193.14
100 x O	0230 194.25	100 x O	0231 194.12	100 x O	0232 194.13	100 x O	0233 194.14	100 x O	0234 194.15
100 x P	0230 195.26	100 x P	0231 195.13	100 x P	0232 195.14	100 x P	0233 195.15	100 x P	0234 195.16
100 x Q	0230 196.27	100 x Q	0231 196.14	100 x Q	0232 196.15	100 x Q	0233 196.16	100 x Q	0234 196.17
100 x R	0230 197.20	100 x R	0231 197.15	100 x R	0232 197.16	100 x R	0233 197.17	100 x R	0234 197.10
100 x S	0230 198.01	100 x S	0231 198.26	100 x S	0232 198.27	100 x S	0233 198.20	100 x S	0234 198.21
100 x T	0230 199.02	100 x T	0231 199.27	100 x T	0232 199.20	100 x T	0233 199.21	100 x T	0234 199.22
100 x U	0230 200.27	100 x U	0231 200.14	100 x U	0232 200.15	100 x U	0233 200.16	100 x U	0234 200.17
100 x V	0230 201.14	100 x V	0231 201.01	100 x V	0232 235.23	100 x V	0233 235.24	100 x V	0234 201.04
100 x W	0230 202.15	100 x W	0231 202.02	100 x W	0232 236.24	100 x W	0233 236.25	100 x W	0234 202.05
100 x X	0230 203.16	100 x X	0231 203.03	100 x X	0232 237.25	100 x X	0233 237.26	100 x X	0234 203.06
100 x Y	0230 204.17	100 x Y	0231 204.04	100 x Y	0232 238.06	100 x Y	0233 238.07	100 x Y	0234 204.07
100 x Z	0230 205.10	100 x Z	0231 205.05	100 x Z	0232 239.07	100 x Z	0233 239.00	100 x Z	0234 205.00

Markers	Marking method	Marker width mm	Marker height, L mm	Use with terminal block thickness
RC55	⑤ ⑩	5	5	5 mm
RC510	⑥ ⑩	5	10	5 mm
RC65	⑤ ⑪	6	5	6 mm
RC610	⑥ ⑪	6	10	6 mm
RC810	⑥ ⑰	8	10	8 mm and larger

RCAL Marker cards for 8 mm spacing spring connection and mini ADO insulation displacement blocks (exclusively).

Each marker card contains 10 strips of 10 markers, i.e. 100 markers per card.
 Material : polyamide. White color with black lettering.

How to use

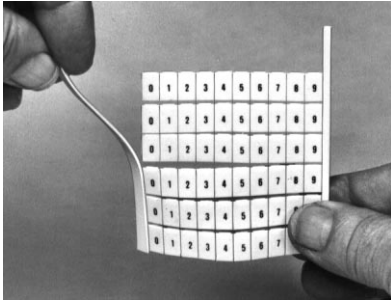

1

Remove one of the side bands of the card.

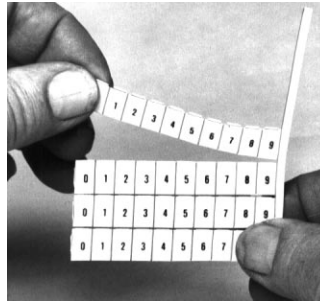

2

Separate the chosen strip from the rest of the card.

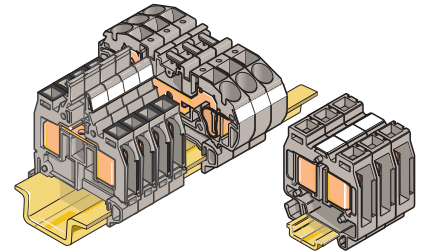

3

Single markers : press the chosen marker in place, hold it, and tear off the rest of the strip.

Marker sizes

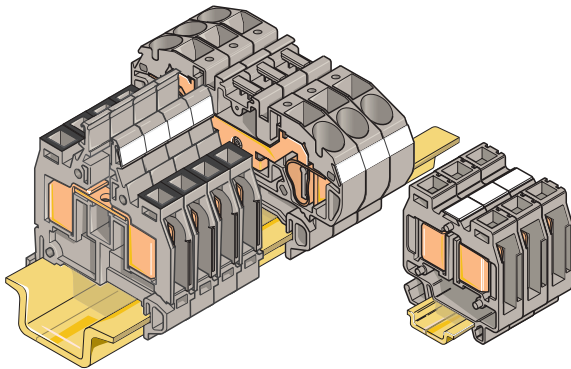

RCAL85
 8 x 5 mm markers
 .315" x .197".
 Can be used on 8 mm .315" spacing mini ADO insulation displacement and spring connection blocks.

Standard marker cards	Marker width mm	Marker height mm	Use with terminal block thickness
RCAL85	8	5	8 mm

Blank cards

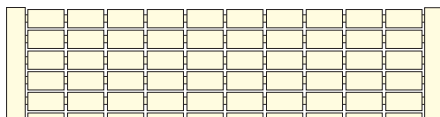

Blank marker cards

RCAL85 0237 000.05

Horizontal marking of numbers

1	2	3	4	5	6	7	8	9	10
11	12	13	14	15	16	17	18	19	20
21	22	23	24	25	26	27	28	29	30
31	32	33	34	35	36	37	38	39	40
41	42	43	44	45	46	47	48	49	50

Horizontal marking
 Increasing order

RCAL85
 1 → 100 0237 030.22

Marker accessories

These markers RCAL85 can be marked using the MAO system, the same way as the markers RC810.

Marking method 5 25

RCT Cards for top marking

Each marker card contains 10 strips of 10 markers, i.e. 100 markers per card. Marker cards are white polyamide with black lettering.

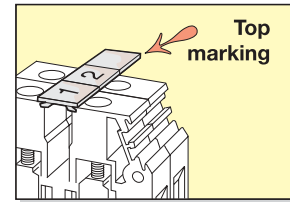

How to use

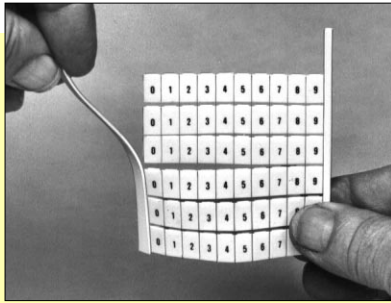

1

Remove one of the side bands of the card.

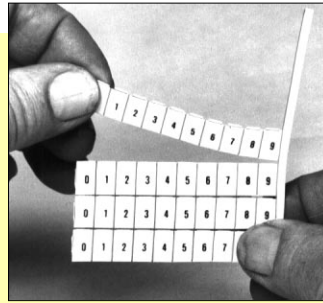

2

Separate the chosen strip from the rest of the card.

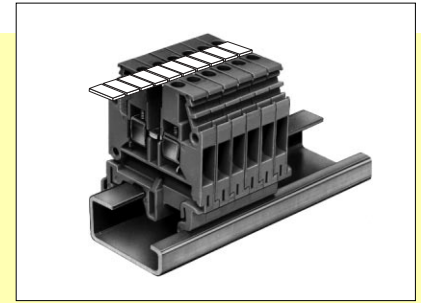

3

- Strips of 10 markers for block spacings 6 and 8 mm :
Press the first marker in place, hold it and slide your thumb on the rest of the strip to snap each marker on the terminal block assembly.
- Single markers :
Press the chosen marker in place, hold it and tear off the rest of the strip.

Marker sizes

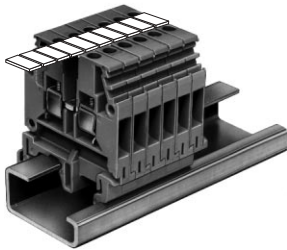

RCT610
6 x 10 mm markers
.238" x .394".
Can be used on block spacing 6 mm, 1 marker per slot.

RCT810
8 x 10 mm markers
.315" x .394".
Can be used on block spacing 8 mm, 1 marker per slot.

Card	Standard marker cards	Marker	Marker width, mm	Marker height, L mm	Use with terminal block thickness
RCT 610	large	6 mm	6	10	6 mm
RCT 810	large	8 mm	8	10	8 mm

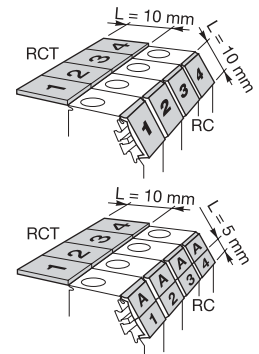

Blank cards

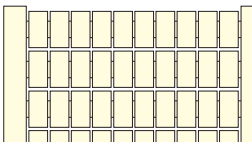

Blank marker cards.

Vertical marking



Vertical marking
Increasing order.

RCT610

0236 000.04

RCT810

0236 500.06

RCT610

1 → 100 0236 001.21

RCT810

1 → 100 0236 501.23

Marker accessories

These markers RCT610 and RCT810 can be marked using the MAO system, the same way as the markers RC610 and RC810.

Marking method 12

RT Top marking strips

RTC Top marking strip for cover

Strip of blank markers to slide in the **CPM** protective cover.

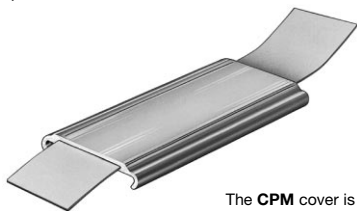

The **CPM** cover is snapped onto the **SCF** separators.

See page 1905, *CPM protective cover*.

✓ Blank

Width : 20 mm .79"
Length : 1 m 39"

RTC **0163 156.27**

RTM Top marking strip for terminal blocks

Strip for top marking : slides on a series of terminal blocks.

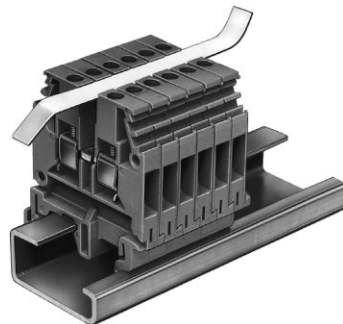

✓ Blank

For blocks with 6 mm .236" to 12 mm .472" spacing.

Width : 7,6 mm .299"
Length : 0,50 m 19.70"

RTM7 **0168 410.07**

Marking method 12

✓ Blank

For blocks with 5 mm .197" and 16 mm .63" spacing.

Width : 10 mm .394"
Length : 0,50 m 19.70"

RTM9 **0164 602.00**

Marking method 13

✓ Black impression on white ground

1 to 50 on one face
51 to 100 on the other
For blocks with 6 mm .238" spacing.
Width : 7,6 mm .299"
Length : 0,50 m 19.70"

RTM7 **0103 115.13**

For blocks with 8 mm .315" spacing.
Width : 7,6 mm .299"
Length : 0,50 m 19.70"

RTM7 **0103 116.14**

For blocks with 10 mm .394" spacing.
Width : 7,6 mm .299"
Length : 0,50 m 19.70"

RTM7 **0103 922.14**

Marking method 12

RCP Pivoting marker card

RCP5 Pivoting marker Spacing 5 mm

They allow marking of groups of terminal blocks.

Clip into the marking slots on blocks **MA 2,5/5, M 4/6, M 6/8, M 10/10, M 16/12**.

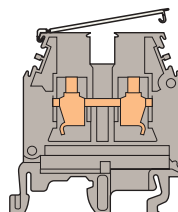

Rotates to allow access to screws without removing the marker. Compatible with RC type individual marking for terminal blocks (see column on right).

Can be installed on adjacent terminal blocks.

Card of 10 pivoting marking strips

RCP5 **0103 888.23**

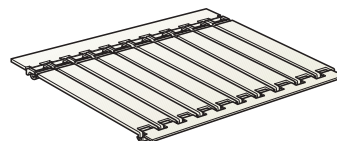

MOUNTING

● PIVOTING MOUNTING

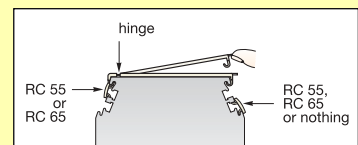
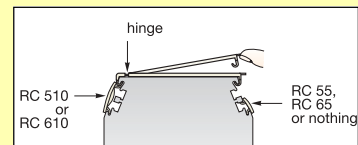

● FIXED MOUNTING

No locking if opposite side is detached.

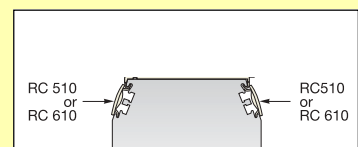
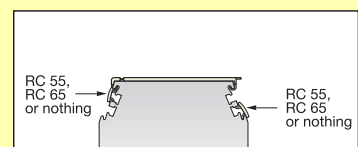

RE Marking with precut markers

REH2 5 x 3,5 mm .197" x .138" markers

Card of 1140 precut markers

✓ Blank

REH2 0163 142.21



✓ Printed

8 series from 001 to 140

REH2 0163 143.22

001	002	003	004	005	006	007	008	009
021	022	023	024	025	026	027	028	029

✓ Printed

8 series from 141 to 280

REH2 0163 148.07

141	142	143	144	145	146	147	148	149
161	162	163	164	165	166	167	168	169

Card of 300 precut markers

✓ Printed

30 series from 001 to 010

REH2 0164 505.27

001	002	003	004	005	006	007	008	009
001	002	003	004	005	006	007	008	009

✓ Printed

15 series from 001 to 020

REH2 0164 506.20

001	002	003	004	005	006	007	008	009
001	002	003	004	005	006	007	008	009

Card of 502 precut markers

✓ Printed

+ 6 series from 001 to 075
+ 2 series from A to Z

REH2 0164 507.21

001	002	003	004	005	006	007	008	009
A	B	C	D	E	F	G	H	I

Marking method ②

REH3 7 x 5 mm .276" x .197" markers

Card of 680 precut markers

✓ Blank

REH3 0163 155.26



✓ Red impression on white background

6 series from 1 to 102
+ 1 series from 103 to 170

REH3 0163 167.22

1	2	3	4	5	6
103	104	105	106	107	108

✓ Red impression on white background

22 series from 1 to 30
+ 1 series from 1 to 20

REH3 0164 695.25

1	2	3	4	5	6
1	2	3	4	5	6

Note: marking on request is black impression on white background.

Marking method ⑱

REH5 10 x 2,8 mm .394 x .110" markers

Card of 781 precut markers

✓ Blank

REH5 0164 630.07



Marking method ⑲

RE 203 20 x 3,5 mm .787" x .138" markers

Card of 296 precut markers

✓ Blank

RE 203 V 0167 996.16



✓ Red impression on white background

6 series from 1 to 160
groups of 4 numbers with 5 mm spacing,
(i.e. 20 mm markers).
+ 1 series from A to Z

RE 203 M 0167 997.17

1	2	3	4	1	2	3	4	1
5	6	7	8	5	6	7	8	5

157	158	159	160	157	158	159	160	157
A	B	C	D	E	F	G	H	I

✓ Red impression on white background

45 series from 01 to 24
groups of 4 numbers with 5 mm spacing,
(i.e. 20 mm markers).

RE 203 M 0175 589.26

09	08	07	06	05	04	03	02	01
09	08	07	06	05	04	03	02	01

09	08	07	06	05	04	03	02	01
09	08	07	06	05	04	03	02	01

✓ Red impression on white background

3 series from 0 to 255
groups of 4 numbers with 5 mm spacing,
(i.e. 20 mm markers).

RE 203 M 0175 590.23

08	07	06	05	04	03	02	01	00
28	27	26	25	24	23	22	21	20

232	231	230	229	228	227	226	225	224
252	251	250	249	248	247	246	245	244

✓ Red impression on white background

5 series from 1 to 120
+ 1 series from 121 to 480
+ 1 special series
groups of 4 numbers or groups of characters
with 5 mm spacing, (i.e. 20 mm markers).

RE 203 M 0175 591.10

1	2	3	4	5	6	7	8	9
21	22	23	24	25	26	27	28	29

0H	1H	2H	3H	4H	5H	6H	7H	8H
20H	21H	22H	23H	0D	1D	2D	3D	4D

Marking method ⑦